

335F L CR

Hydraulic Excavator



Engine

Engine Model	Cat® C7.1 ACERT™	
Net Power – SAE J1349	149 kW	200 hp

Drive

Maximum Travel Speed	4.2/2.6 km/h
Maximum Drawbar Pull	295 kN

Weight

Minimum Operating Weight	34 845 kg
Maximum Operating Weight	38 376 kg

The new Cat 335F L CR is the largest compact radius machine available from any major manufacturer today. The type of up-close, space-restricted work you can do with such a unique, heavy-duty machine is nearly unlimited.

Powered by a new fuel-efficient EU Stage IV C7.1 ACERT engine, the machine comes equipped with roughly 7.7 mt of counterweight out back, durable structures built for a lifetime of service, and a state-of-the-art hydraulic system that puts all the energy in your hands so you can move tons of material – literally – all day long with tremendous stability, speed, and precision.

When you add in standard high-ambient cooling along with an available cold weather package, a full-size ROPS cab that keeps you comfortable and productive, easy-to-reach service points that make your routine maintenance fast and simple, and multiple Cat work tools and tool control options that help you take on a variety of tasks, you simply won't find a better, more versatile 35-ton excavator – one more than capable of working year round on any project, any place, anywhere.

Contents

Compact Radius4
 Integrated Technologies5
 Reliable and Productive6
 Fuel Efficient8
 Easy to Operate10
 Durable Linkages12
 Durable Structures13
 Versatile14
 Serviceable16
 Safe Work Environment17
 Complete Customer Care18
 Sustainable19
 Specifications20
 Standard Equipment29
 Optional Equipment30





If your business calls for a tool-carrying machine that can take on several tight-quarter tasks like loading trucks without swinging into traffic, picking and placing heavy materials, and even taking down structures to make way for progress, you need the versatile Cat 335F L CR in your fleet. In this size class, there simply isn't anything like it. In fact, it's in a class of its own.



Compact Radius

Work with greater confidence in tight quarters

Less Tail

The demand for excavators capable of working in tight quarters continues to grow, and Caterpillar is meeting the need – from the mini 301.7D CR all the way up to the new 335F L CR. The market’s largest compact radius machine will help you take on some of the heaviest up-close work with confidence knowing you won’t hit a wall or an oncoming vehicle when you swing because it has only 152.4 mm of overhang.

More Stability

The 335F L CR utilizes the long, heavy-duty undercarriage from the large 336F L excavator. Measuring 5020 mm, this platform provides much greater stability when lifting heavy objects, which leads to greater overall productivity.

Better Lift

The 335F L CR is designed to deliver greater lift capability out front and over the side than the model it’s replacing. Two major contributors are increased hydraulic pressure and flow.

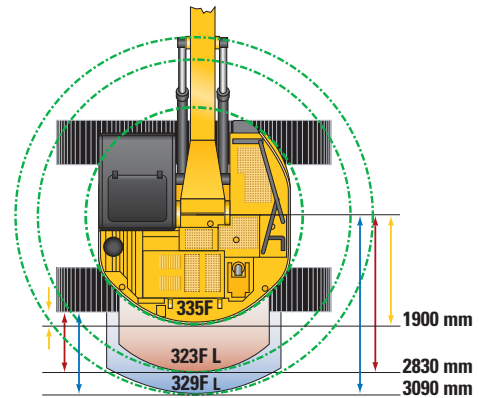

Integrated Technologies

Monitor, manage, and enhance job site operations



Cat Connect makes smart use of technology and services to improve your job site efficiency. Using the data from technology-equipped machines, you'll get more information and insight into your equipment and operations than ever before.

Cat Connect technologies offer improvements in these key areas:



EQUIPMENT
MANAGEMENT

Equipment Management – increase uptime and reduce operating costs.



PRODUCTIVITY

Productivity – monitor production and manage job site efficiency.



SAFETY

Safety – enhance job site awareness to keep your people and equipment safe.

LINK Technologies

LINK technologies, like Product Link™, are deeply integrated into your machine and wirelessly communicates key information, including location, hours, fuel usage, idle time and event codes.

Product Link/VisionLink®

Easy access to Product Link data via the online VisionLink user interface can help you see how your machine or fleet is performing. You can use this information to make timely, fact based decisions that can boost job site efficiency and productivity, and lower costs.



Reliable and Productive

Power to move your material with speed and precision



Ground-Breaking Design

When it comes to moving heavy material quickly and efficiently, you need hydraulic horsepower – the type of ground-breaking power the 335F L CR can deliver. Major hydraulic components like the main pump and main control valve are located close together so shorter tubes and lines can be used. This design leads to less friction loss, reduced pressure drops, greater fuel efficiency, and more power to the ground for the work you need to get done.

Control Like No Other

Controllability is one of the key attributes of Cat excavators, and one of the main contributors to this is the main control valve. The valve opens slowly when your joystick lever movement is small and opens rapidly when movement is high. It directs flow where you need it when you need it, which leads to smoother operation, greater efficiency, and lower fuel consumption.

Tool Control Above The Others

Caterpillar's standard tool control system gives you just the right amount of pressure you need to work with a variety of tools, including grapples, shears, and multiprocessors. Unique to Cat machines is the ability for you to pre-program up to 10 different tools through the machine's monitor to make switching for the job at hand simple and easy to do, which will save you time and money compared to other brands' manual systems.

Auxiliary Hydraulics For Added Versatility

Auxiliary hydraulic circuits give you added versatility, and there are several factory-installed options from which you can choose. You can have a single function circuit to run a hammer and compactor or a double function circuit to run a thumb or tilt bucket. A quick coupler circuit allows you to switch from one tool to another in a matter of minutes – all from the comfort and convenience of the cab.

Boom & Stick Oil Re-Circulation For Added Efficiency

The 335F L CR regenerates the flow of oil from the head end of the boom and stick cylinders to the rod end of the boom and stick cylinders during the work cycle to save energy and improve fuel efficiency. It's optimized for any dial speed setting you select, which results in less pressure loss for higher controllability, more productivity, and lower operating costs for you.



Fuel Efficient

Engineered to lower your operating costs





Fuel Savers That Add Up

The 335F L CR consumes up to 16% less fuel than the D Series model it's replacing, and lowering engine speed without impacting production is one of the key contributors. Automatic engine speed control also contributes by lowering rpm when the machine doesn't need it for work. Automatic engine idle shutdown turns the engine off when it's been idling for more than a specified amount of time that you can set through the monitor. Plus you have a choice of three power modes – high power, standard power, and eco mode. Simply change between modes through the console switch panel to meet the work needs in front of you. Collectively, all of these benefits add up to lower fuel consumption, less exhaust and sound emissions, reduced repair and maintenance costs, and increased engine life for you.

A Cooling Design For Any Temperature

The machine's cooling system is built to work in extreme conditions. The system is completely separated from the engine compartment to reduce noise and heat. Plus it features easy-to-clean cores and a variable-speed fan that runs only when needed to ensure maximum efficiency.

Biodiesel Not A Problem

The C7.1 ACERT engine can run on up to B20 biodiesel that meets ASTM 6751 standards – all to give you more potential fuel-saving flexibility.

Proven Technology

Every Stage IV ACERT engine is equipped with a combination of proven electronic, fuel, air, and aftertreatment components. Applying these time-tested technologies lets us meet your high expectations for productivity, fuel efficiency, reliability, and service life. Following are the results you can expect:

- **Improved fuel efficiency**, with minimized Diesel Exhaust Fluid (DEF) consumption.
- **High performance** across a variety of applications.
- **Enhanced reliability** through commonality and simplicity of design.
- **Maximized uptime and reduced cost** with world-class Cat dealer support.
- **Minimized impact** on emission systems – with no operator interaction required.
- **Durability** with long service life.
- **Better fuel economy** with minimized maintenance costs.
- **Same great power** and response.

Easy to Operate

Comfort and convenience to keep you productive





A Safe, Quiet Cab

The ROPS cab provides you with a safe working environment. It also contributes to your comfort because it's attached to a reinforced frame with special viscous mounts that limit vibration and unnecessary sound. Add in special roof lining and sealing and you have a cab that's as quiet inside as today's top highway trucks.

Excellent Ergonomics

Wide seats with air suspension and heat/cooling options, include a reclining back, upper and lower slide adjustments, and height and tilt angle adjustments to meet your needs for maximum comfort.

The fully automatic climate control system keeps operators comfortable and productive all day long in either hot or cold weather.

Storage spaces are located in the front, rear, and side consoles of the cab. A drink holder accommodates a large mug, and a shelf behind the seat stores large lunch or toolboxes.

Power supply sockets are available for charging your electronic devices like an MP3 player, a cell phone, or even a tablet.

Controls Just For You

The right and left joystick consoles can be adjusted to improve your comfort and productivity during the course of a day. The right joystick features a button that will reduce engine speed when you are not working to help save fuel. Touch it once and speed reduces; touch it again and speed increases for normal operation.

Easy To Navigate Monitor

The new LCD monitor is easy to see and navigate. Not only can it memorize up to 10 different work tools, it's also programmable in up to 42 languages to meet today's diverse workforce. The monitor clearly displays critical information you need to operate efficiently and effectively. Plus it projects the image from the standard rearview camera to help you see what's going on around you so you can stay safely focused on the job at hand.



Durable Linkages

Options to take on your far-reaching and up-close tasks

Built To Last

The 335F L CR is offered with a 6.15 m reach boom and a 3.2 m stick. Each is built with internal baffle plates for added durability, and each undergoes ultrasound inspection to ensure weld quality and reliability. Large box-section structures with thick, multi-plate fabrications, castings, and forgings are used in high-stress areas such as the boom nose, boom foot, boom cylinder, and stick foot to improve durability. The boom nose pin is a captured flag design for enhanced durability.

Pins

All front linkage pins have thick chrome plating, giving them high wear resistance. Each pin diameter is made to distribute the shear and bending loads associated with the stick and to help ensure long pin, boom and stick life.

Talk to your Cat dealer to pick the best front linkage for your specific line of work.

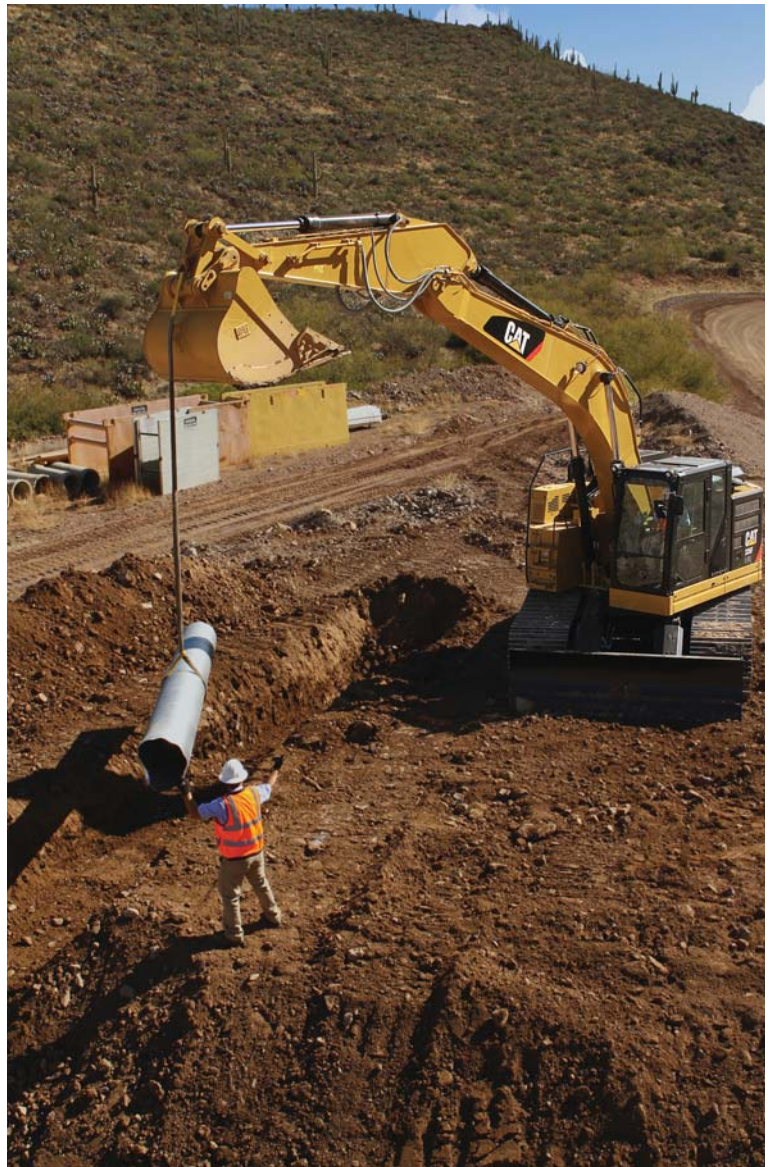

Durable Structures

Built to work in your rugged applications



Robust Frame

The 335F L CR is a well-built machine designed to give you a very long service life. The upper frame has mountings made specifically to support the heavy-duty cab; it is also reinforced around key areas that take on stress like the boom foot and skirt. Massive bolts are used to attach the track frames to the body, and additional bolts are used to increase the machine's digging force, which leads to more productivity for you.



Stable Undercarriage

The 335F L CR undercarriage contributes significantly to its outstanding stability and durability. Track shoes, links, rollers, idlers, and final drives are all built with long-lasting, high-tensile-strength steel. Cat Grease Lubricated Track 2 (GLT2) track link protects moving parts by keeping water, debris, and dust out and grease sealed in, which delivers longer wear life and reduced noise when traveling. Optional track guiding guards help maintain track alignment to improve the machine's overall performance – whether you're traveling on a flat, heavy bed of rock or a steep, wet field of mud.



Great Balance

The 7.7 mt counterweight is built with thick steel plates and reinforced fabrications to make it less susceptible to damage, the counterweight has curved surfaces that match the machine's sleek, smooth appearance along with an integrated housing to help protect the standard rearview camera.

Versatile

Do more jobs with one machine





Get the Most from One Machine

The 335F L CR is a versatile machine that packs a lot of performance into a small package. You can easily expand that performance by utilizing a variety of attachments offered by Cat Work Tools.

Change Jobs Quickly

Cat quick couplers bring the ability to quickly change attachments and switch from job to job. The Cat Universal coupler is the secure way to decrease downtime and increase job site flexibility and overall productivity.

Dig, Rip and Load

A wide range of buckets dig everything from basic top soil to extreme, harsh material like ore and high quartzite granite. Rip through rock as an alternative to blasting in quarries. High-capacity buckets load trucks in a minimum number of passes for maximum productivity.

Break, Demolish and Scrap

A hydraulic hammer ably equips your machine for breaking rock in quarries. It will also make taking down bridge pillars and heavily reinforced concrete on road demolition jobs no problem.

Multi-processor and pulverizer attachments make your machine ideal for demolition jobs and processing the resulting debris. Shears with 360° rotation mount to the machine for processing scrap steel and metal.

Set Up Your Machine for Profitability

Your Cat dealer can install hydraulic kits to properly operate all Cat Work Tool attachments, maximizing the machine's uptime and your profit.



1) Universal Quick Coupler 2) G300 Series Demolition and Sorting Grapples 3) General Duty (GD) 4) Heavy Duty (HD) 5) Severe Duty (SD) 6) Extreme Duty (XD)

Serviceable

Designed to make your maintenance quick and easy

Safe, Convenient Access

You can reach most routine maintenance items like fluid taps and grease points from the safety and convenience of ground level. You will also find filters banked together for higher service efficiency. Compartments feature wide service doors designed to help prevent debris entry, and they also securely latch in place to help make your service work simpler. The engine hood features a gas cylinder to assist to make opening and closing easy.

Easy Cleaning

The high-ambient cooling system features a fuel-saving variable-speed fan and a side-by-side-mounted radiator and oil and air coolers for easy cleaning. Wider clearance between the two makes blowing off debris easy for you, which can help improve your machine's reliability and performance.

A Fresh Idea

When you select ventilation inside the cab, outside air enters through the fresh air filter. The filter is conveniently located on the side of the cab to make it easy to reach and replace, and it is protected by a lockable door that can be opened with the engine key.

More Service Benefits

The DEF tank is conveniently located beneath a lockable door. Filters are banked together to enhance service efficiency. The fuel tank's drain cock makes it easy and simple for you to remove water and sediment during routine maintenance. Plus an integrated fuel level indicator pops up to help you reduce the possibility of fuel tank overfilling.



Safe Work Environment

Features to help protect you day in and day out

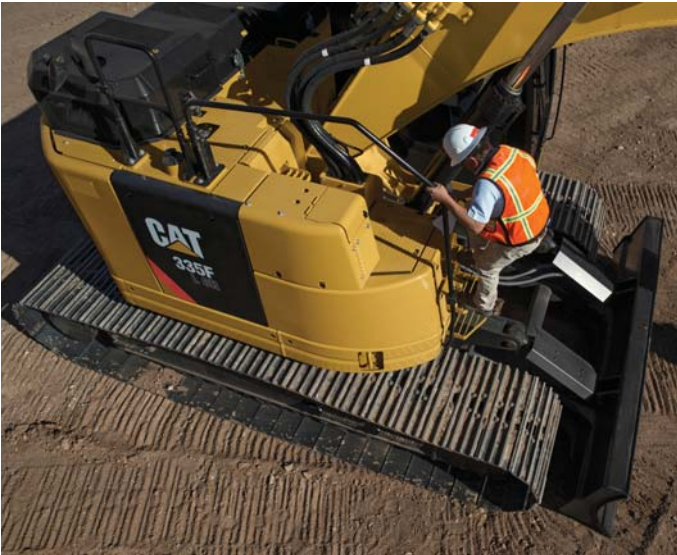

A Safe, Quiet Cab

The ROPS cab provides you with a safe working environment when properly seated and belted. It also contributes to your comfort because it's attached to a reinforced frame with special viscous mounts that limit vibration and unnecessary sound. Add in special roof lining and sealing and you have a cab that's as quiet inside as any of today's top pickup trucks.

Secure Contact Points

Multiple large steps get you into the cab as well as a leg up to the compartments. Extended hand and guard rails allow you to safely climb to the upper deck. Anti-skid plates reduce your slipping hazards in all types of weather conditions, and they can be removed for cleaning.

Great Views

Ample glass gives you excellent visibility out front and to the side, and the standard rearview camera gives you a clear field of view behind the machine through the cab monitor. The available split-configuration windshield features an upper window with handles that make it easy to slide and store above you and a lower window that can be removed and stored on the inside wall of the cab. The large skylight also serves as an emergency exit and provides you with enhanced overhead visibility.

Smart Lighting

Halogen lights provide plenty of illumination, and the cab and boom lights can be programmed to stay on for up to 90 seconds after the engine has been turned off to help you safely exit the machine.



Complete Customer Care

Unmatched support makes the difference

Worldwide Parts Availability

Cat dealers utilize a worldwide parts network to maximize your machines' uptime. Plus they can help you save money with Cat remanufactured components.

Advice You Can Trust

What are the job requirements and machine attachments? What production is needed? Your Cat dealer can provide recommendations to help you make the right machine choices.

Financial Options Just For You

Consider financing options and day-to-day operating costs. Look at dealer services that can be included in the machine's cost to yield lower owning and operating costs over time.

Support Agreements To Fit Your Needs

Cat dealers offer a variety of customer support agreements and work with you to develop a plan to meet your specific needs. These plans can cover the entire machine, including attachments, to help protect your investment.

Operating Techniques To Boost Your Profits

Improving operating techniques can boost your profits. Your Cat dealer has videos, literature, and other ideas to help you increase productivity. Caterpillar also offers simulators and certified operator training to help maximize the return on your investment.

What's Best For You Today... And Tomorrow

Repair, rebuild, or replace? Your Cat dealer can help you evaluate the cost involved so you can make the best choice for your business.

Sustainable

Generations ahead in every way



- The C7.1 ACERT engine meets Stage IV emission standards.
- The 335F L CR burns 16% less fuel than the Stage IIIA 328D model it replaces, which means less emissions.
- The machine has the flexibility of running on either ultra-low-sulfur diesel (ULSD) fuel with 10 ppm of sulfur or less or biodiesel (up to B20) fuel blended with ULSD.
- A ground-level overfill indicator rises when the tank is full to help the operator avoid spilling.
- The machine is built to be rebuilt with major structures and components capable of being remanufactured to reduce waste and replacement costs.
- Overall, the 335F L CR is an efficient, productive machine that's designed to conserve our natural resources for generations ahead.

335F L CR Hydraulic Excavator Specifications

Engine

Engine Model	Cat C7.1 ACERT	
Net Power – ISO 9249	149 kW	203 hp (metric)
Power – ISO 14396	152 kW	207 hp (metric)
Bore	105 mm	
Stroke	135 mm	
Displacement	7.01 L	

Weights

Minimum Operating Weight*	34 845 kg	
Maximum Operating Weight**	38 376 kg	

*Long undercarriage, 600 mm TG track, reach boom, R3.2CB2 stick, CB2 bucket linkage and CB1233HD 1.7 m³ bucket.

**Long undercarriage, 850 mm TG track, blade, reach boom, R3.2CB2 m stick, CB2 bucket linkage, CB1350HD 1.54 m³ bucket.

Track

Number of Shoes Each Side	49
Number of Track Rollers Each Side	9
Number of Carrier Rollers Each Side	2

Swing Mechanism

Swing Speed	9.9 rpm
Swing Torque	82.2 kN·m

Drive

Gradeability	30°/70%
Maximum Travel Speed	4.2/2.6 km/h
Maximum Drawbar Pull	295 kN

Hydraulic System

Main System	
Maximum Flow (Total)	493.2 L/min
Implement × 2 pumps	246.6 L/min
Swing system – Maximum Flow	
	No swing pump
Maximum Pressure – Equipment – Normal	
	35 000 kPa
Maximum Pressure – Travel	
	37 000 kPa
Maximum Pressure – Heavy Lift	
	38 000 kPa
Maximum Pressure – Swing	
	27 400 kPa
Pilot System Maximum Flow	
	30 L/min
Pilot System Maximum Pressure	
	4100 kPa
Boom Cylinder – Bore	
	140 mm
Boom Cylinder – Stroke	
	1407 mm
Stick Cylinder – Bore	
	150 mm
Stick Cylinder – Stroke	
	1646 mm
Bucket Cylinder (CB) – Bore	
	150 mm
Bucket Cylinder (CB) – Stroke	
	1151 mm

Service Refill Capacities

Fuel Tank Capacity	385 L
Cooling System	30 L
Engine Oil	24 L
Swing Drive (each)	9 L
Final Drive (each)	8 L
Hydraulic System Oil (including tank)	290 L
Hydraulic Tank Oil	154 L
DEF Tank	23 L

Sound Performance

ISO 6395 (External)	104 dB
ISO 6396 (Inside Cab)	72 dB

- When properly installed and maintained, the cab offered by Caterpillar, when tested with doors and windows closed according to ANSI/SAE J1166OCT98, meets OSHA and MSHA requirements for operator sound exposure limits in effect at time of manufacture.
- Hearing protection may be needed when operating with an open operator station and cab (when not properly maintained or doors/windows open) for extended periods or in a noisy environment.

Standards

Brakes	ISO 10265 2008
Cab/FOGS	ISO 10262 1998
Cab/ROPS	ISO 12117-2 2008

335F L CR Hydraulic Excavator Specifications

Dimensions

All dimensions are approximate.

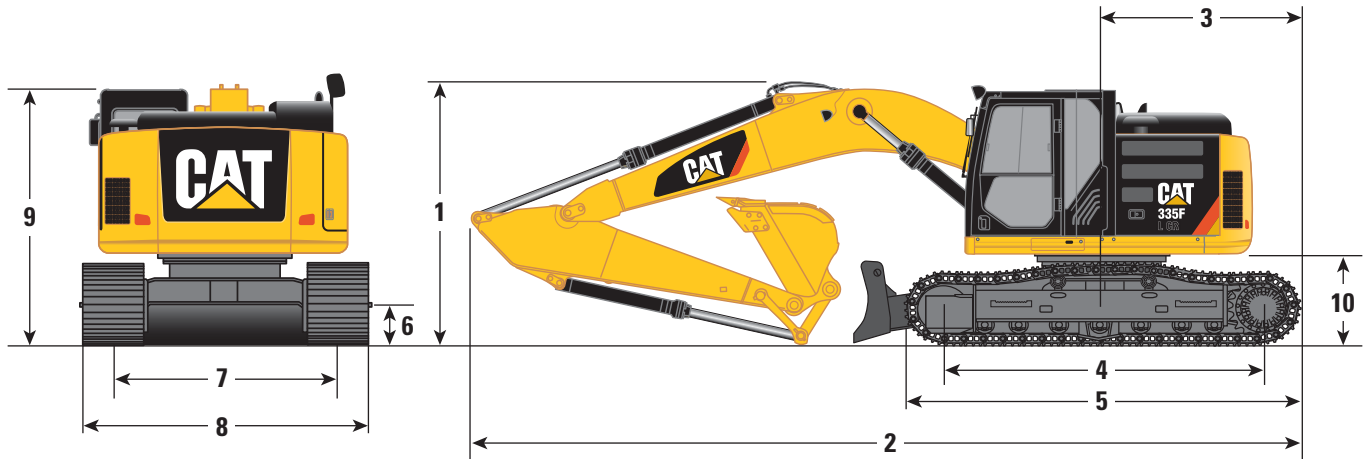

Boom Options	Reach Boom 6.15 m
Stick Options	HD R3.2CB2
1 Shipping Height*	3540 mm
2 Shipping Length	9820 mm
3 Tail Swing Radius	1900 mm
4 Length to Center of Rollers	4040 mm
5 Track Length	5020 mm
6 Ground Clearance**	480 mm
7 Track Gauge	2590 mm
8 Transport Width	
600 mm Shoes	3190 mm
700 mm Shoes	3290 mm
850 mm Shoes	3440 mm
9 Cab Height*	3260 mm
10 Counterweight Clearance**	1200 mm
Bucket Type	GD
Bucket Tip Radius	1650 mm
Bucket Capacity	1.54 m ³

*Including shoe lug height

**Without shoe lug height

335F L CR Hydraulic Excavator Specifications

Working Ranges

All dimensions are approximate.

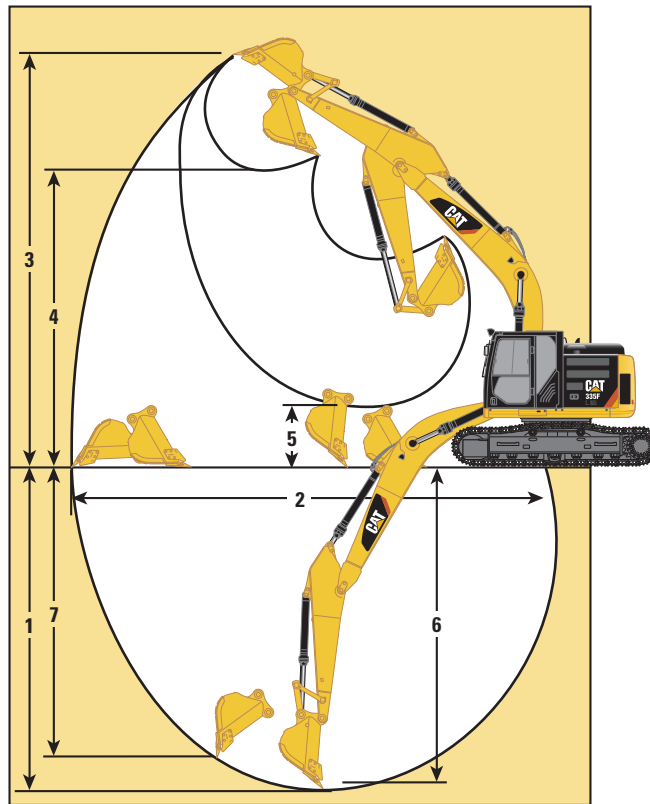

Boom Options

Reach Boom
6.15 m

Stick Options

3.2 m

1 Maximum Digging Depth	6990 mm
2 Maximum Reach at Ground Level	10 640 mm
3 Maximum Cutting Height	11 150 mm
4 Maximum Loading Height	7970 mm
5 Minimum Loading Height	2920 mm
6 Maximum Cut Depth	6830 mm
7 Maximum Depth Cut for 2440 mm Level Bottom	6830 mm
8 Maximum Vertical Wall Digging Depth	5770 mm
Bucket Type	GD
Bucket Tip Radius	1650 mm
Bucket Capacity	1.54 m ³
Cutting Edge Bucket Digging Force (ISO)	179 kN
Cutting Edge Stick Digging Force (ISO)	126 kN

335F L CR Hydraulic Excavator Specifications

Operating Weights and Ground Pressures

			Without Blade				With Blade	
			600 mm		850 mm		600 mm	
			Triple Grouser Shoes		Triple Grouser HD Shoes		Triple Grouser Shoes	
			Weight	Ground Pressure	Weight	Ground Pressure	Weight	Ground Pressure
kg	kPa	kg	kPa	kg	kPa			
Reach Boom	Stick	Bucket						
6.15 m	R3.2CB2 (3.2 m)	CB1350HD	34 935	65.1	36 234	47.6	37 077	69.1

Operating weight is based on ISO 6016: Machine (upper and lower structure), front structure, 100% full fuel tank, fluids at normal level (i.e.: oils/water/lubricants), bucket (currently = "VVV Major Bucket") without fill materials, 75 kg operator.

Notes: No optional attachments are included, the bucket is empty.

The minimum and maximum operating weights currently shown in Specalogs are based on differences between front structures, tracks, and buckets.

The minimum and maximum operating weight does not consider optional attachments, nor factor different bucket sizes or couplers unless specified by GCI.

335F L CR Hydraulic Excavator Specifications

Major Component Weights

Base Machine – Includes: Boom Cylinders, Pins, Fluids	9349 kg
Full Fuel Tank	320 kg
Counterweight	7700 kg
Boom (includes lines, pins, and stick cylinder)	
Reach Boom (6.15 m)	2450 kg
Stick (includes lines, stick pins, bucket pins, and bucket cylinder)	
R3.2CB2	1150 kg
Bucket Linkage	
CB2	462 kg
Undercarriage	8232 kg
Track Shoe	
600 mm TG Shoe	4066 kg
850 mm TG HD Shoe	5365 kg
Blade (3200 mm)	2142 kg
Common Buckets	
Bucket: CB1233HD 1.3 m ³	1047 kg
Bucket: CB1350HD 1.54 m ³	1131 kg
Bucket: CB1500GD 1.71 m ³	1041 kg
Quick Couplers	
Quick Coupler: Pin Grabber Type CB without Pin	502 kg
Quick Coupler: Pin Grabber Type CB with Pin	532 kg
Quick Coupler: Universal CW45	464 kg
Quick Coupler: Universal CW45s	435 kg

335F L CR Hydraulic Excavator Specifications

Reach Boom Lift Capacities – Counterweight: 7.7 mt – with Bucket Linkages, without Bucket, without Blade – Heavy Lift On

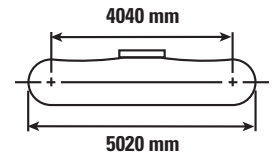
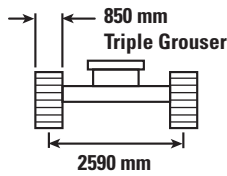
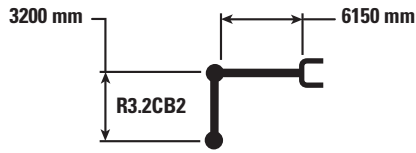

Reach (mm)	Unit	1500 mm		3000 mm		4500 mm		6000 mm		7500 mm		9000 mm		mm		
		Diagram 1	Diagram 2	Diagram 1	Diagram 2	Diagram 1	Diagram 2	Diagram 1	Diagram 2	Diagram 1	Diagram 2	Diagram 1	Diagram 2	Diagram 1	Diagram 2	
9000 mm	kg							*6350	*6350					*6200	*6200	6040
7500 mm	kg							*8100	*8100					*5550	*5550	7440
6000 mm	kg							*8600	*8600	*8050	6050			*5350	5100	8330
4500 mm	kg			*17 050	*17 050	*11 850	*11 850	*9650	8300	*8500	5950			*5350	4550	8890
3000 mm	kg					*14 700	12 000	*11 000	7900	*9150	5750	*6750	4350	*5500	4250	9160
1500 mm	kg					*16 750	11 350	*12 150	7550	9350	5550	7150	4300	*5850	4150	9180
0 mm	kg			*6050	*6050	*17 300	11 050	*12 700	7350	9200	5400			*6500	4250	8950
-1500 mm	kg	*7550	*7550	*11 450	*11 450	*16 650	10 950	*12 500	7250	9150	5350			*7550	4600	8440
-3000 mm	kg			*18 300	*18 300	*14 850	11 050	*11 300	7300	*8400	5450			*8200	5350	7600
-4500 mm	kg			*15 050	*15 050	*11 550	11 300	*8400	7500					*7650	7050	6300



ISO 10567



*Indicates that the load is limited by hydraulic lifting capacity rather than tipping load. The above loads are in compliance with hydraulic excavator lift capacity standard ISO 10567:2007. They do not exceed 87% of hydraulic lifting capacity or 75% of tipping load. Weight of all lifting accessories must be deducted from the above lifting capacities. Lifting capacities are based on the machine standing on a firm, uniform supporting surface. The use of a work tool attachment point to handle/lift objects, could affect the machine lift performance.

Lift capacity stays with ±5% for all available track shoes.

Always refer to the appropriate Operation and Maintenance Manual for specific product information.

335F L CR Hydraulic Excavator Specifications

Reach Boom Lift Capacities – Counterweight: 7.7 mt – with Bucket Linkages, without Bucket, without Blade – Heavy Lift On

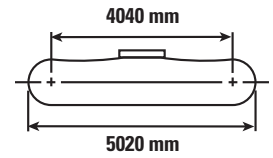
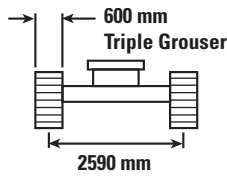
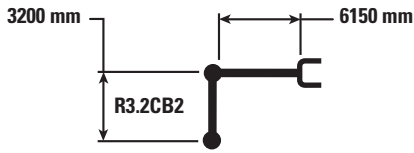

Reach (mm)	Unit	1500 mm		3000 mm		4500 mm		6000 mm		7500 mm		9000 mm		mm		
		Diagram	Diagram	Diagram	Diagram	Diagram	Diagram	Diagram	Diagram	Diagram	Diagram	Diagram	Diagram	Diagram	Diagram	
9000 mm	kg							*6350	*6350					*6200	*6200	6040
7500 mm	kg							*8100	*8100					*5550	*5550	7440
6000 mm	kg							*8600	8300	*8050	5850			*5350	4900	8330
4500 mm	kg			*17 050	*17 050	*11 850	*11 850	*9650	8000	*8500	5700			*5350	4350	8890
3000 mm	kg					*14 700	11 600	*11 000	7600	*9150	5500	*6750	4200	*5500	4100	9160
1500 mm	kg					*16 750	10 900	*12 150	7250	9000	5350	6900	4100	*5850	4000	9180
0 mm	kg			*6050	*6050	*17 300	10 600	12 350	7050	8850	5200			*6500	4100	8950
-1500 mm	kg	*7550	*7550	*11 450	*11 450	*16 650	10 550	12 250	6950	8800	5150			7450	4400	8440
-3000 mm	kg			*18 300	*18 300	*14 850	10 600	*11 300	7000	*8400	5200			*8200	5150	7600
-4500 mm	kg			*15 050	*15 050	*11 550	10 900	*8400	7200					*7650	6750	6300



ISO 10567



*Indicates that the load is limited by hydraulic lifting capacity rather than tipping load. The above loads are in compliance with hydraulic excavator lift capacity standard ISO 10567:2007. They do not exceed 87% of hydraulic lifting capacity or 75% of tipping load. Weight of all lifting accessories must be deducted from the above lifting capacities. Lifting capacities are based on the machine standing on a firm, uniform supporting surface. The use of a work tool attachment point to handle/lift objects, could affect the machine lift performance.

Lift capacity stays with $\pm 5\%$ for all available track shoes.

Always refer to the appropriate Operation and Maintenance Manual for specific product information.

335F L CR Hydraulic Excavator Specifications

335F L CR (with or without blade) Work Tool Offering Guide*

Boom Option	Reach Boom
Stick Option	R32 (HD)
Hammer	H120Es H130Es H140Es
Multi-Processor	MP324 CC Jaw MP324 D Jaw MP324 P Jaw** MP324 U Jaw MP324 S Jaw MP324 TS Jaw**
Mobile Scrap and Demolition Shear	S320B S325B** S340B#
Pulverizer	P225
Crusher	P325
Demolition and Sorting Grapple (D-Demolition, R-Recycling Shells)	G320B-D/R G325B-D**
Compactor (Vibratory Plate)	CVP110
Orange Peel Grapple	
Clamshells	
Rippers	
Pin Grabber Coupler	
Dedicated Quick Coupler	

These work tools are available for the 335F L CR.
Consult your Cat dealer for proper match.

*Offerings not available in all areas. Matches are dependent on excavator configurations. Consult your Cat dealer to determine what is offered in your area and for proper work tool match.

**Pin-on or Dedicated coupler.

***Pin-on only.

#Boom mount.

335F L CR Hydraulic Excavator Specifications

Bucket Specifications and Compatibility

	Linkage	Width mm	Capacity m ³	Weight kg	Fill %	With Blade	Without Blade
						600 mm TG	600 mm TG
						Reach Boom	Reach Boom
						R3.2	R3.2
Without Quick Coupler							
General Duty (GD)	CB	750	0.71	730	100%	●	●
	CB	1050	1.12	864	100%	●	●
	CB	1200	1.33	927	100%	●	●
	CB	1350	1.54	1009	100%	●	●
	CB	1500	1.76	1074	100%	⊙	⊙
Heavy Duty (HD)	CB	1350	1.54	1134	100%	●	⊙
	CB	1500	1.76	1229	100%	⊙	⊖
Severe Duty (SD)	CB	1350	1.56	1245	90%	●	●
Maximum load pin-on (payload + bucket)					kg	4583	4194
With Quick Coupler (CW45, CW45s)							
General Duty (GD)	CB	750	0.7	693	100%	●	●
	CB	1350	1.5	1008	100%	●	⊙
	CB	1500	1.76	1074	100%	⊙	⊖
	CB	1650	1.97	1157	100%	⊖	○
Heavy Duty (HD)	CB	1200	1.33	1061	100%	●	●
	CB	1350	1.54	1134	100%	⊙	⊖
	CB	1500	1.76	1229	100%	⊖	○
	CB	1650	1.97	1302	100%	⊖	○
Maximum load pin-on (payload + bucket)					kg	4119	3730

Maximum Material Density:

- 2100 kg/m³
- ⊙ 1800 kg/m³
- ⊖ 1500 kg/m³
- 1200 kg/m³

The above loads are in compliance with hydraulic excavator standard EN474, they do not exceed 87% of hydraulic lifting capacity or 75% of tipping capacity with front linkage fully extended at ground line with bucket curled.

Capacity based on ISO 7451.

Bucket weight with General Duty tips.

Caterpillar recommends using appropriate work tools to maximize the value customers receive from our products. Use of work tools, including buckets, which are outside of Caterpillar's recommendations or specifications for weight, dimensions, flows, pressures, etc. may result in less-than-optimal performance, including but not limited to reductions in production, stability, reliability, and component durability. Improper use of a work tool resulting in sweeping, prying, twisting and/or catching of heavy loads will reduce the life of the boom and stick.

Standard Equipment

Standard equipment may vary. Consult your Cat dealer for details.

CAB

- Radial wiper
- Mirrors
- Pressurized operator station with positive filtration
- Laminated glass front upper window and tempered other windows
- Sliding upper door window (left-hand cab door)
- Removable tempered lower windshield with in-cab storage bracket
- Windshield, 70-30 split, sliding, removable lower windshield with in cab storage bracket
- Openable skylight
- Interior
 - Glass-breaking safety hammer
 - Coat hook
 - Beverage holder
 - Literature holder
 - Interior lighting
 - AM/FM radio mounting (DIN size)
 - Two 12V stereo speakers
 - Storage shelf suitable for lunch or toolbox
 - Power supply with 12V, two power outlets (10 amp)
 - Thumb wheel modulation joystick for use with combined auxiliary control
 - Air conditioner, heater and defroster with climate control
- Seat
 - Seat belt, 51 mm
 - Adjustable high-back, heated seat with air suspension
 - Adjustable armrest
 - Height adjustable joystick consoles
 - Neutral lever (lock out) for all controls
 - Travel control pedals with removable hand levers
 - Capability of installing two additional pedals
 - Two speed travel
 - Floor mat, washable

- Monitor
 - Clock
 - Distortion free rear vision camera
 - Video ready
 - Color LCD display with warning, filter/fluid change, and working hour information
 - Language display (full graphic and full color display)
 - Machine condition, error code and tool mode setting information
 - Start-up level check for engine oil, engine coolant and hydraulic oil
 - Warning, filter/fluid change and working hour information
 - Fuel consumption meter

ELECTRICAL

- 115 amp alternator
- Circuit breaker
- Battery, standard, maintenance free

ENGINE

- Cat C7.1 ACERT diesel engine
- Meets EU Stage IV emission standards
- 4600 m altitude capability with derate from 3000 m
- Biodiesel capable
- Automatic engine speed control
- Electric priming pump
- Economy and standard power modes
- Radial seal air filter with double filter element
- Water level indicator for water separator
- Automatic engine idle shutdown
- Three-stage fuel filtration system with water separator and indicator
- 52° C high ambient capability

HYDRAULIC SYSTEM

- Boom and stick lowering control devices with SmartBoom™
- Reverse swing dampening valve
- Automatic swing parking brake
- High-performance hydraulic return filter
- Regeneration circuit for boom and stick
- Capability of installing additional auxiliary circuits
- One-touch lifting mode
- Automatic two-speed travel

LIGHTS

- One frame, two cab, and two boom lights with time delay

UNDERCARRIAGE/UPPER FRAME

- Grease Lubricated Track link
- Towing eye on base frame
- Counterweight, 7.7 mt
- HD bottom guard
- HD track rollers

SERVICE & MAINTENANCE

- Grouped oil, fuel, and hydraulic oil filters for ease of maintenance
- Sampling ports for Scheduled Oil Sampling (S·O·SSM)
- Air-to-air aftercooler (ATAAC) and fixed-type A/C condenser

SAFETY AND SECURITY

- Cat one key security system
- Door locks
- Cap locks on fuel and hydraulic tanks
- Lockable external tool/storage box
- Signaling/warning horn
- Ground-level-accessible secondary engine shutoff switch in cab
- Mirrors
- Rear vision camera
- Capability to connect a beacon
- Neutral lever for all controls
- Bolt-free service platform with anti-skid plate and handrails
- Safety hammer for cab evacuation

INTEGRATED TECHNOLOGIES

- Product Link
- Rear vision camera

335F L CR Optional Equipment

Optional Equipment

Optional equipment may vary. Consult your Cat dealer for details.

FRONT LINKAGE

- Reach Boom 6.15 m (with BLCV/SLCV)
 - R3.2m stick
 - CB2-family bucket linkage (with lifting eye)
- Universal coupler
- Pin grabber coupler

UNDERCARRIAGE

- 600 mm triple grouser
- 850 mm triple grouser
- Blade, 3200 mm

GUARDS

- Track guiding guards
 - Full length
 - Segmented, 3 pieces

HYDRAULIC SYSTEM

- HP hydraulic lines for boom and stick
- MP hydraulic lines for boom and stick
- QC hydraulic lines for boom and stick
- QC control

ELECTRICAL

- Cold weather starting package, –32° C

ENGINE

- Air cleaner with precleaner

For more complete information on Cat products, dealer services, and industry solutions, visit us on the web at www.cat.com

AEHQ7419 (03-2015)

© 2015 Caterpillar
All rights reserved

Materials and specifications are subject to change without notice. Featured machines in photos may include additional equipment. See your Cat dealer for available options.

CAT, CATERPILLAR, SAFETY.CAT.COM, their respective logos, "Caterpillar Yellow" and the "Power Edge" trade dress, as well as corporate and product identity used herein, are trademarks of Caterpillar and may not be used without permission.

VisionLink is a trademark of Trimble Navigation Limited, registered in the United States and in other countries.

